

Systems

PA28R-201 ARROW

Engine

Make : Avco Lycoming

Model:

IO-360 C1C6

Type:

- 4 cylinders
- Horizontally opposed
- Normally aspirated(No turbo charge)
- Air cooled (Engine oil and fuel helps cooling)
- Direct drive(Propeller is attached to the crank shaft directly without any reduction gear or transmission)
- Fuel injected

Horsepower: 200 BHP

Propeller

Make: McCauley

Model: B2D34C213

Type: Constant speed propeller

What is a constant speed prop?

The propeller which maintains the RPM selected by propeller control lever constant regardless of airplane's pitch attitude or throttle position within some range.

The advantage of a constant speed prop.

The pilot can select the most efficient blade angle for each phases of operation. By selecting low pitch/high RPM, you can get maximum power for takeoff. By selecting high pitch/low RPM, you can fly faster at low RPM and you can save the fuel for cruise.

How does it work?

When the airplane rise it's nose, it start climb. As it climb, airspeed goes down. The RPM is also going down due to increasing drag on the blade. However, blade angle is decreased automatically to reduce the drag to maintain the RPM constant.

When the airplane drops it's nose, it start to descend. As it descend, airspeed will increse. The RPM is also increased due to decreasing drag on the blade. However, blade angle is increased automatically to increase the drag to maintain the RPM constant.

McCAULEY PROPELLER SYSTEMS
OWNER/OPERATOR
INFORMATION MANUAL

C320

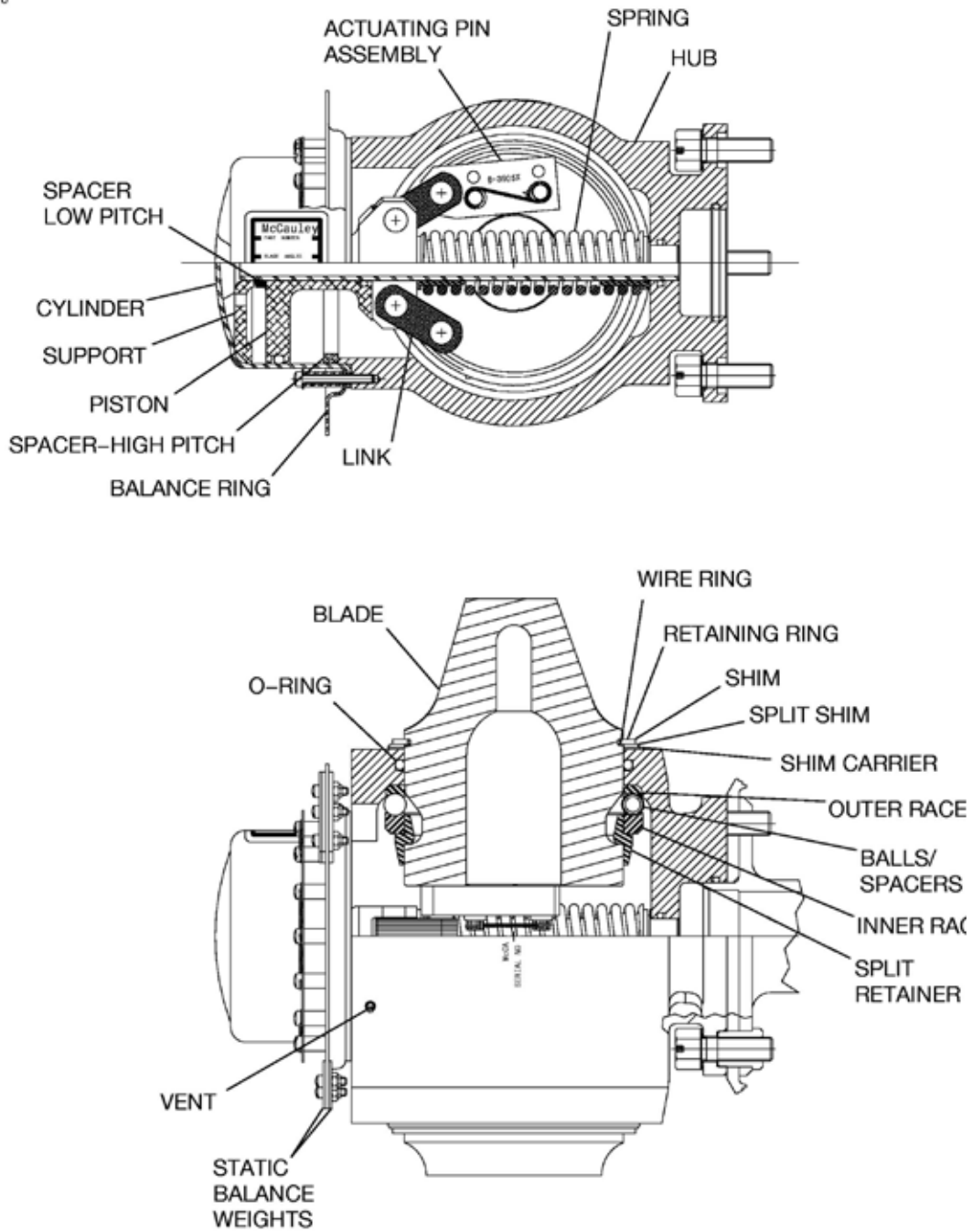

NON OIL FILLED

0

C200 Series Propeller
Figure 1 (Sheet 1)

61-00-04

Where is the governor located?

Behind the engine.

What does governor do?

The fly weight inside the governor senses the change in RPM by sensing the change in centrifugal force. It opens the pilot valve. When the RPM increase, the valve opens the line with the pump. It send the oil to propeller hub to increase the blade angle. When the RPM decrease, the valve opens the line without the pump. It drains the oil back from propeller hub to decrease the blade angle.

What makes it high pitch?

High pressure of the oil.

What makes it low pitch?

Spring in the hub and aerodynamic force on the prop.

What does pilot do when he move the prop lever in the cockpit? What will happen to governor?

It change the tension of the speeder spring. High tension requires more centrifugal force on the fly weight. It increase the RPM. Low tension requires less centrifugal force on the fly weight. It decrease the RPM.

Where is the oil from?

Engine oil reservoir at the bottom of the engine.

What will happen if you lose engine oil completely?

It become lowest pitch. Moves toward high RPM.

Fuel system

What is the fuel system of the Arrow?

Fuel pump system.

How many fuel pumps are there?

Two. Engine driven fuel pump and electrical fuel pump.

What drives fuel pumps?

Engine driven and electrical motor.

When do you use electrical fuel pump?

To start the engine.

Takeoff, climb and landing.

When the engine driven pump is inoperative.

How many fuel tanks are there?

One tank in each wing. Total two tanks.

What is the capacity of each tanks(total/usable)?

38.5 gallons in each tanks. Total 77 gallons. 2.5 gallons unusable each side makes usable fuel of 72 gallons. Also 25 gallons usable to the tab in each tank makes total 50 gallons usable.

How many fuel gauges are there?

Three. Fuel quantity gauges. Fuel pressure gauges. Fuel flow gauge.

Draw the fuel system.

Refer P.O.H.

How many drains are there? Where are they located?

Three. One at the bottom of each wing tank and one on the fuel filter.

What is the minimum grade of fuel?

100.

How can you make sure you have correct fuel?

Color. 100 is green. 100 LL is blue.

How many positions does the fuel selector valve have?

Three. Right , Left and Off. No both position. For this reason, better fuel management is needed. Usually, switch tank every 30 minutes.

Landing gear

Type of the landing gear?

Tri-cycle, retractable.

How does it work?

It is electrical-hydraulic system. Pilot can select the position(up/down) by the gear handle. The electrical motor rotate the hydraulic pump which send the hydraulic fluid from reservoir to three actuators. The fluid move the piston in each actuators to move the push-pull rod which are connected to the landing gears.

When the hydraulic pressure reached to certain amount, the pressure switch disconnect the circuit to stop the pump. When the hydraulic pressure decrease, pressure switch activate the motor to pump the hydraulic fluid.

Each landing gears (nose gear and right, left main gear) have up limit switch and down limit switch. Up limit switch extinguish the red unsafe light when all three are pressed. Down limit switch stop the motor when all three are pressed. It also turns on the green lights.

Where is the power pack located?

Behind the baggage compartment.

What is the color of the hydraulic fluid?

Red.

What will happen in the case of loss of hydraulic fluid?

The gear will drop by gravity and spring.

How can you make sure it is down and locked?

Three green lights.

Lock systems(up/down).

Up-No mechanical lock. Only supported by hydraulic pressure.

Down-Over center lock supported by spring and finger hook.

What is the maximum speed you can extend/retract the gear?

Vle is 129 KIAS. However, for retraction, it must be below 107 KIAS.

Is there any system which warns you when you forget to extend the gear for a landing?

There is warning horn. When the throttle is reduced(14”) with gear up, it beeps. When the flap is extended at 25 or 40 degree with gear up, it beeps(only N37574). It beeps on the ground when the gear handle is up.

And gear unsafe light (red) illuminates if it not fully down or fully up.

Arrow N2496M and N2073M have back up extender (automatic extension system) which drops the gear automatically when pilot forget to extend it for landing.

There is a mast on the left side of the fuselage which has ram air inlet and static port. The combination of low airspeed and low power setting (less propeller wash) send less dynamic air pressure into the diaphragm below the rear seat. Then the push-pull rod connected to the diaphragm push the valve and open it. The hydraulic fluid supporting the gear in up position is now released and return to the reservoir through this valve. The gear will go down by the gravity. You will see three green lights and red unsafe warning light. No warning horn.

If the gear is automatically down, pilot need to move gear handle “down” to avoid undesired gear retraction due to adding power on final to adjust the path or speed. When the power is added, valve will be closed and the pump will be activated to retract the gear.

The emergency gear lever has three position. OVERRIDE, NORMAL and EMERGENCY DOWN.

OVERRIDE-The automatic extension system is disabled. The yellow light will be flashing all the time.

NORMAL-The automatic extension system is active.

EMERGENCY DOWN-You can manually open the valve to release the hydraulic pressure. The gear will go down by the gravity and the spring.

What will happen if you move gear handle up while you taxi on the ground?

The warning horn beeps. And gear unsafe light (red) illuminates The gear will not go up because of the squat switch located on the left main gear strut.

What would you do if you don't see green light after you move the gear handle down?

Check master switch on, circuit breaker in, push the light bulb for test, switch the light bulb, turn the instrument panel light off(which dims green lights). Check if you hear warning horn or not. Check unsafe light.

Explain the manual extension procedure.

Use check list.

Slow down to 87 KIAS.

Landing gear lever-down.

Pull emergency gear extension knob.

Check three green lights.

Leave emergency gear extension knob pulled.

What makes gear down when you use manual extension system?

It release the hydraulic pressure. The gravity and the spring pulls gear down.

Electrical system

What is the primary source of electricity?

Alternator

How many alternators are there?

One

What drives the alternator?

Engine

What is the voltage and capacity of the alternator?

14 volt, 60 Am

How can it maintain the voltage constant while the engine RPM changes from phase to phase?

Voltage regulator maintain it at 14 volt regardless of RPM.

What is happening if you see over voltage warning light(alternator annunciator light)?

Over voltage relay shut down the alternator field as a result of over voltage(more than 16.5 volt) caused by spike or voltage regulator failure. Recycle the master switch and/or alternator.

How can you make sure one the alternators is working or not?

Turn off the alternator and make sure the load meter shows zero.

What is bus bar? Location?

Bus bar is a piece of metal used for the distribution of the electricity. It simplify the wiring. It is located behind the circuit breakers.

How can you detect the alternator failure? What would you do then?

Alternator annunciator light on and the load meters indicate zero. First, turn off avionics master, then recycle master switch. If it still indicate zero, turn off the master switch to conserve the battery.

How many batteries are there? Location?

Behind the baggage compartment.

What is the voltage and capacity of the battery?

12 volt, 25 amh.

How long does the battery last after losing alternator?

Depend on the load. If you use 25 am continuously, it last 1 hour. If you use 50 am continuously, it last 1/2 hour.

Flight control system

Conventional cable and pulley system.

Flap

Type of flap: Single slotted

How does it work?

Flap is actuated manually by human power.

Maximum deflection: 40 degrees

Vfe: 103 KIAS.

Vacuum system

Purpose

To operate the gyro instruments. AI and HI.

Source of vacuum

Engine driven vacuum pumps.

Normal indication

4.8 ~5.1 in-hg

How to detect the failure

Low indication of the vacuum gauge and vacuum warning light.

Stall warning system

Electrical warning horn activated with tabs on the left wing.

Heater

Hot air around the exhaust shroud is directed to the cabin.

Ice protection: Pitot heat, carb heat

Hydraulic system: Prop, Brakes, Landing gear

V speed:KIAS

Va: 118(2,750lb)

Vx: 72(gear down), 78(gear up)

Vy: 78(gear down), 90(gear up)

Vs0: 55

Vs1: 60

Vno:146

Vne:183

Vfe:103

Vle: 129

Vr: 60~71 depends on the weight

Before Maneuver Check

1. Seat belt-Fasten.
2. Fuel selector valve-On
3. Mixture-Rich.
4. Fuel pump-On
5. Master switch-On

Clearing turn

Complete 90 degrees turn to the left, and 90 degrees turn to the right. Depend on the airspace and terrain, right turn may be the first. Watch the blind spot on the left, right, behind and below. Bank should be 15 to 20 degrees.

Slow Flight

Entry

1. Throttle-15 in, maintain altitude.

As you reduce power, you should anticipate pitch down. Don't watch manifold pressure gauge needle to move from cruise to 15 in. Look at the horizon and cowling as you use peripheral vision. Adjust control pressure to avoid nose from dropping and adjust rudder to keep the heading constant.

2. Airspeed 129kt, Landing gear-Down
3. Airspeed 100kt-Flap 10
90kt-Flap 25
80kt-Flap 40

The extension of flap cause nose to move up. If you allow it, you will gain altitude. Anticipate this and you need to add slight forward pressure on the control wheel to avoid this. Watch horizon and cowling. Don't fix your eyes on the airspeed indicator and the flap switch. After you set full flap, you need to apply back pressure to keep the altitude constant.

4. Airspeed 75kt-Prop to high RPM
5. Airspeed 65kt-Throttle, 17 in-18 in, maintain 60kt

Add right rudder as you add power to compensate the left turning tendency. PTS require you to maintain minimum controllable airspeed which is almost 55kt for Seminole. However, you need to be able to fly at any speed. Use trim. After this point, generally, pitch controls airspeed and power controls altitude. Remember the pitch attitude which gives you 60 kt.

Climb

Apply extra power. Adjust pitch to maintain the airspeed. For level off, reduce power necessary to maintain the altitude. Adjust pitch to maintain the airspeed.

Descent

Reduce power as necessary. Adjust pitch to maintain the airspeed. For level off, add power necessary to maintain the altitude. Adjust pitch to maintain the airspeed.

Turn

Use 10 degrees bank. Try to maintain pitch attitude and adjust it to maintain 60 kt.

Recovery

1. Throttle-Full, maintain the altitude.

Adjust pitch "gradually" to maintain the altitude. Don't push nose down quickly. Pitch should be changed slowly from slow flight attitude(high) to cruise attitude(level). Look at the horizon and cowling as you scan the altimeter.

2. Flap-25
3. Airspeed 70kt-Landing gear-up, Flap 10
4. Airspeed 80kt-Flap Up

The flap retraction cause the nose to move down. You need to anticipate and add back pressure as necessary to maintain the altitude. As airspeed increases, you don't need much right rudder anymore.
Airspeed

5. 90 kt-Throttle Cruise. Prop and mixture set back to cruise. Return to cruise flight. Use trim.

Power Off Stall

Entry

1. Throttle-15 in
Maintain altitude
2. Airspeed Below 129kt-Landing gear-down
3. Airspeed 100kt-Flap 10
90kt-Flap 25
80kt-Flap 40
4. Airspeed 75kt-Prop to high RPM
1 through 4 are same as slow flight.
5. Start descend at 75kt
6. Throttle-idle. Increase back pressure to keep altitude to reach stall.

Recovery

1. Release back pressure.
You don't need to push nose down too steep.
2. Throttle-Full, Maintain level flight attitude.
Don't look inside the cockpit. Your right hand is already on the throttle. Just move it forward. Look horizon and cowling. Adjust control pressure to establish level flight attitude.
3. Flap-25
After retract the flap to 25, return your right hand on the throttle. Wait for the airspeed to increase as you maintain level flight attitude.
4. Airspeed 72kt (V_x), Climb attitude
Look at horizon and the cowling to establish normal climb attitude. And wait.
5. Positive climb-Landing gear-Up, Flap 10
Avoid pitch change caused by flap retraction.
6. Airspeed 78kt (V_y)-Flap Up
7. Level off, Airspeed 90kt-Throttle, Prop, Mixture- Cruise,

Power On Stall

Entry

1. Throttle-15 in

Maintain altitude

2. Airspeed Below 129 kt, Landing gear-Down
3. Airspeed 75 kt, Prop-High RPM
4. Airspeed 72kt(V_x)-Throttle full, Climb attitude (slightly higher than normal climb attitude)

No need to pull nose up very high. If the nose is too high, it will drop a lot and lose excessive altitude after stall. To avoid this, maintain the pitch slightly higher than normal climb attitude at which airspeed is decreasing gradually (about 15 degrees up). Add back pressure to keep this pitch attitude constant as airspeed decrease. Look at the horizon on the both side of the cowling to judge your attitude.

Recovery

1. Release back pressure. Maintain level flight attitude.

Release back pressure gently to return to the level pitch. Wait for the airspeed to increase.

2. Airspeed 72kt(V_x), Climb attitude
3. Positive climb, Landing gear-Up
4. Airspeed 78 kt(V_y)-Stabilize climb, then level off.

Since the power on stall is the simulation of the departure stall, the altitude you begin this maneuver is the airport elevation. During recovery, you shouldn't go below the original altitude. If you do so, that mean you crash on the ground. You should finish this maneuver at higher altitude than you begin.

5. Airspeed 90kt-Throttle, Prop, Mixture- Cruise,

Accelerated stall (Commercial pilot)

At least 3000 AGL for both SE and ME

1. Throttle 15 in-hg, maintain altitude
2. 80 kt (Arrow), Prop-High RPM
3. 45 degrees bank coordinated turn
4. Increase back pressure to reach stall
5. Stall indication, release back pressure, increase power, bank zero, return to level flight

Secondly Stall (demonstrated-CFI only)

Entry

1. Throttle-15 in
Maintain altitude
2. Airspeed Below 129kt-Landing gear-down
3. Airspeed 100kt-Flap 10
90kt-Flap 25
80kt-Flap 40
4. Airspeed 75kt-Prop to high RPM
1 through 4 are same as slow flight.
5. Start descend at 75kt
6. Throttle-idle. Increase back pressure to keep altitude to reach stall.
7. Stall indication, release back pressure.
8. Increase back pressure abruptly.

Recovery

1. Release back pressure.
You don't need to push nose down too steep.
2. Throttle-Full, Maintain level flight attitude.
Don't look inside the cockpit. Your right hand is already on the throttle. Just move it forward. Look horizon and cowling. Adjust control pressure to establish level flight attitude.
3. Flap-25
After retract the flap to 25, return your right hand on the throttle. Wait for the airspeed to increase as you maintain level flight attitude.
4. Airspeed 72kt (V_x), Climb attitude
Look at horizon and the cowling to establish normal climb attitude. And wait.
5. Positive climb-Landing gear-Up, Flap 10
Avoid pitch change caused by flap retraction.
6. Airspeed 78kt (V_y)-Flap Up
7. Level off, Airspeed 90kt-Throttle, Prop, Mixture- Cruise,

Elevator Trim Stall (demonstrated-CFI only)

Entry

1. Throttle-15 in
 Maintain altitude
2. Airspeed Below 129kt-Landing gear-down
3. Airspeed 100kt-Flap 10
 90kt-Flap 25
 80kt-Flap 40
4. Airspeed 75kt-Prop to high RPM
 1 through 4 are same as slow flight.
5. Start descend at 75kt, set trim for pitch up
6. Throttle-Full, simulating go-around.

Recovery

1. Apply forward pressure for level pitch attitude.
 You don't need to push nose down too steep.
2. Flap-25
 After retract the flap to 25, return your right hand on the throttle. Wait for the airspeed to increase as you maintain level flight attitude.
3. Airspeed 72kt (V_x), Climb attitude
 Look at horizon and the cowling to establish normal climb attitude. And wait.
4. Positive climb-Landing gear-Up, Flap 10
 Avoid pitch change caused by flap retraction.
5. Airspeed 78kt (V_y)-Flap Up
6. Level off, Airspeed 90kt-Throttle, Prop, Mixture- Cruise,

Crossed Control Stall (demonstrated- CFI only)

Entry

1. Throttle-Idle
Maintain altitude
2. Airspeed Below 129kt-Landing gear-down
3. Airspeed 80kt-Prop to high RPM
4. Start descend at 75kt
5. Enter turn..
 - Increase rudder input in the direction of turn.
 - Use opposite aileron to decrease bank.
 - Increase back pressure to keep altitude to reach stall.

Recovery

1. Release back pressure.
You don't need to push nose down too steep.
2. Throttle-Full, Maintain level flight attitude.
Don't look inside the cockpit. Your right hand is already on the throttle. Just move it forward. Look horizon and cowling. Adjust control pressure to establish level flight attitude.
3. Airspeed 72kt (V_x), Climb attitude
Look at horizon and the cowling to establish normal climb attitude. And wait.
4. Positive climb-Landing gear-Up,
5. Climb at 78kt (V_y)
6. Level off, Airspeed 90kt-Throttle, Prop, Mixture- Cruise,

Emergency Descent

Entry

1. Throttle- Idle, begin descent
2. Airspeed <129, Gear down
3. Prop High RPM
4. Maintain 120 kt with bank as needed.

Recovery

5. Target altitude+200ft, Nose- Level pitch
6. Airspeed<107, Gear up
7. Power- Cruise

Steep Turn

1. Set up
 - Thottle-20"
 - Prp-2500RPM
 - AS-110Kt
2. Enter turn with aileron and rudder.
3. When the bank > 30
 - Apply back pressure to keep ALT,
 - Add power to keep AS
4. When the bank = 45 (Private) / 50 (Commercial), counter aileron to keep bank constant
5. 20 degree before target heading,
 - Start roll out with aileron and rudder
 - Release back pressure
 - Return to level flight attitude
 - Thottle-20"
6. For Commercial, reverse the course to the other direction immediately.

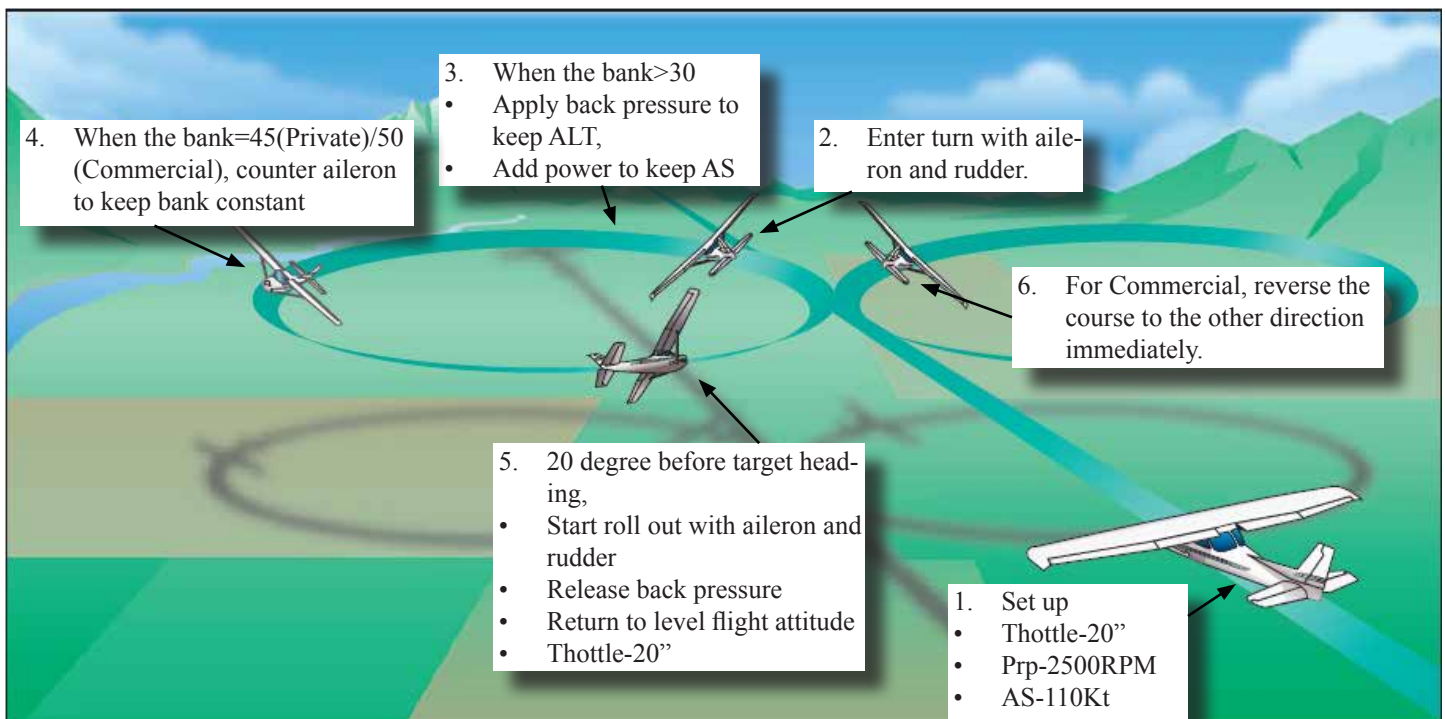

Steep Spiral

Climb high enough to complete three turns above 1000 ft AGL. Select reference point close to you.

Entry

1. Straight-and-level.
2. Abeam
3. Throttle- Idle
4. Gear-Down
5. Begin descent and turn with 45 degrees bank
6. Prop-High RPM
7. Maintain 90kt
8. Adjust bank angle to keep distance constant
9. Open throttle momentary to avoid spark plug from fouling after each turns on upwind
10. Continue three turns

Recovery

1. Nose- Level pitch
2. Airspeed<107, Gear up
3. Power- Cruise

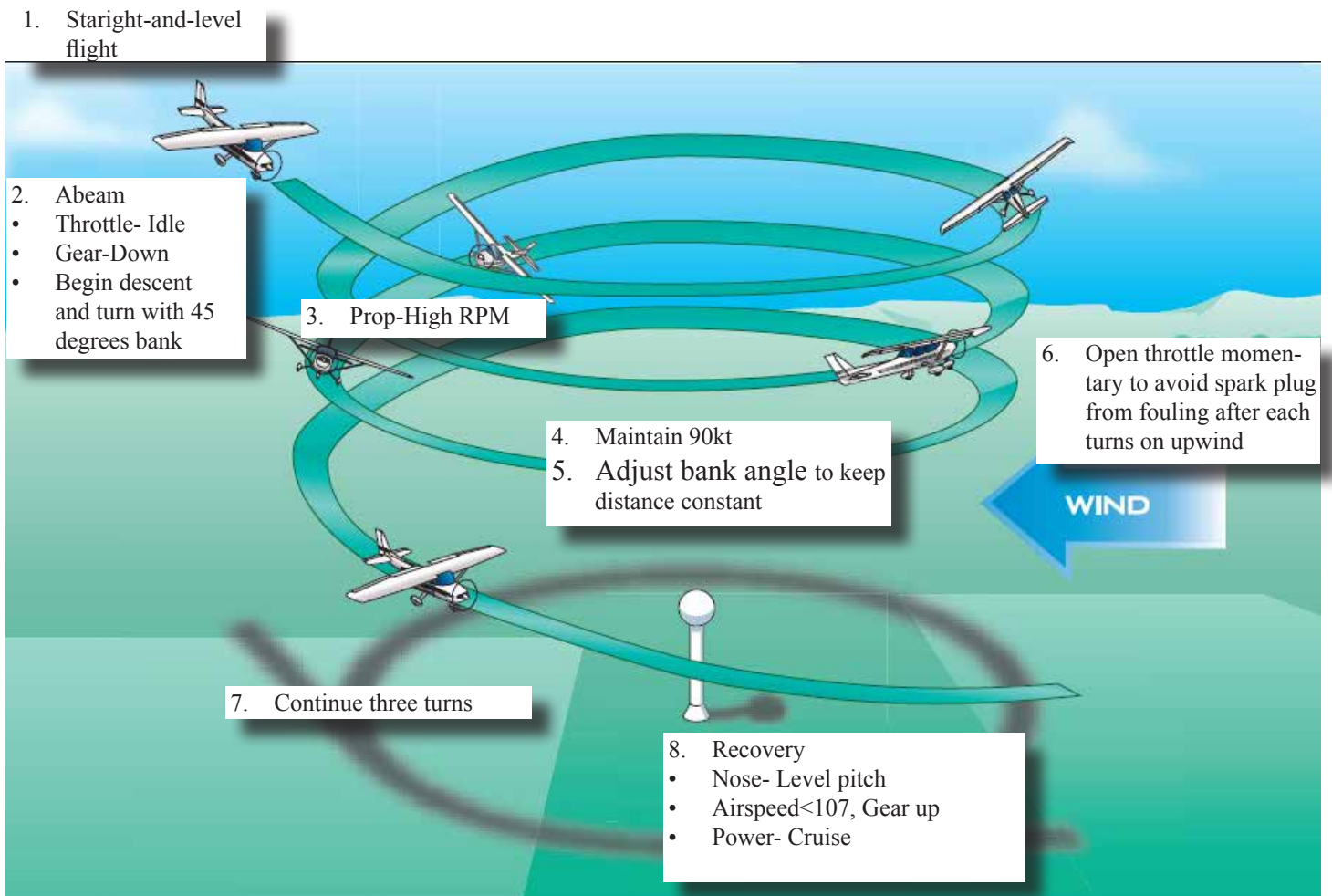

Chandelle

Straight-and-level flight at or below V_a (Throttle 22", Prop-high RPM)

Entry

- 30 degrees bank(Use aileron and rudder).
- Start climb
- Full power.

90 degrees point

- Start roll-out gradually.
- Maintain pitch attitude constant(apply back pressure)

180 degree point

- Wing level.
- Airspeed 60~65kt.
- Hold that attitude momentary.

Level off. Maintain altitude.

Airspeed 90kt-Throttle, Prop-Cruise setting.

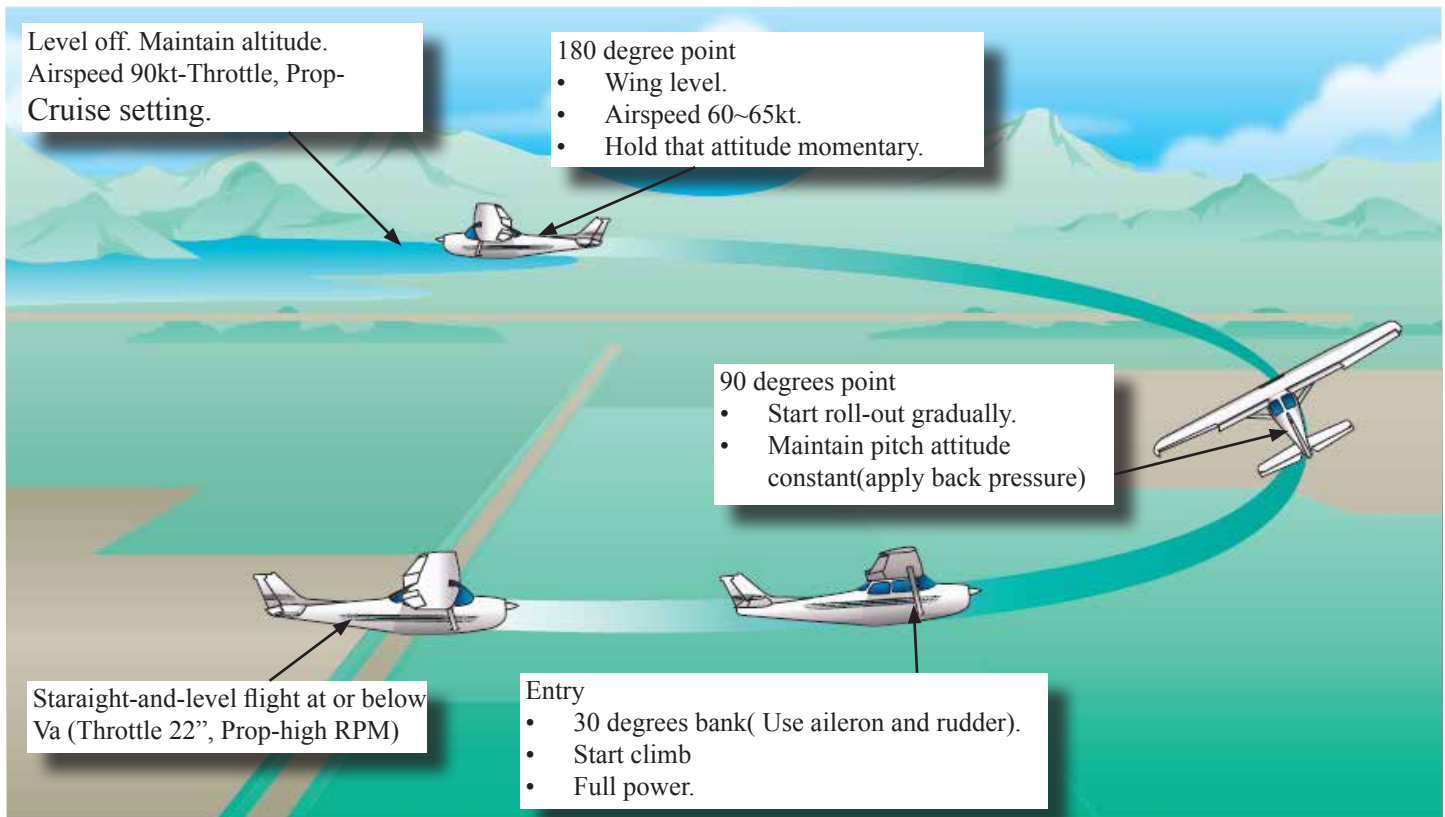

Lazy Eights

Entry:

1. Level flight
2. Throttle 19~20", Prop 2300 RPM (Maneuvering or cruise speed whichever is less or manufacturer's recommended speed).

45° Point

1. Max. Pitch-up attitude
2. Bank 15° (approx.)

90° Point

1. Bank approx 30°
2. Minimum speed
3. Maximum altitude
4. Level pitch attitude

135° Point

1. Max. Pitch-down
2. Bank 15°(approx.)

180° Point

1. Level flight
2. Entry airspeed
3. Altitude same as Entry altitude

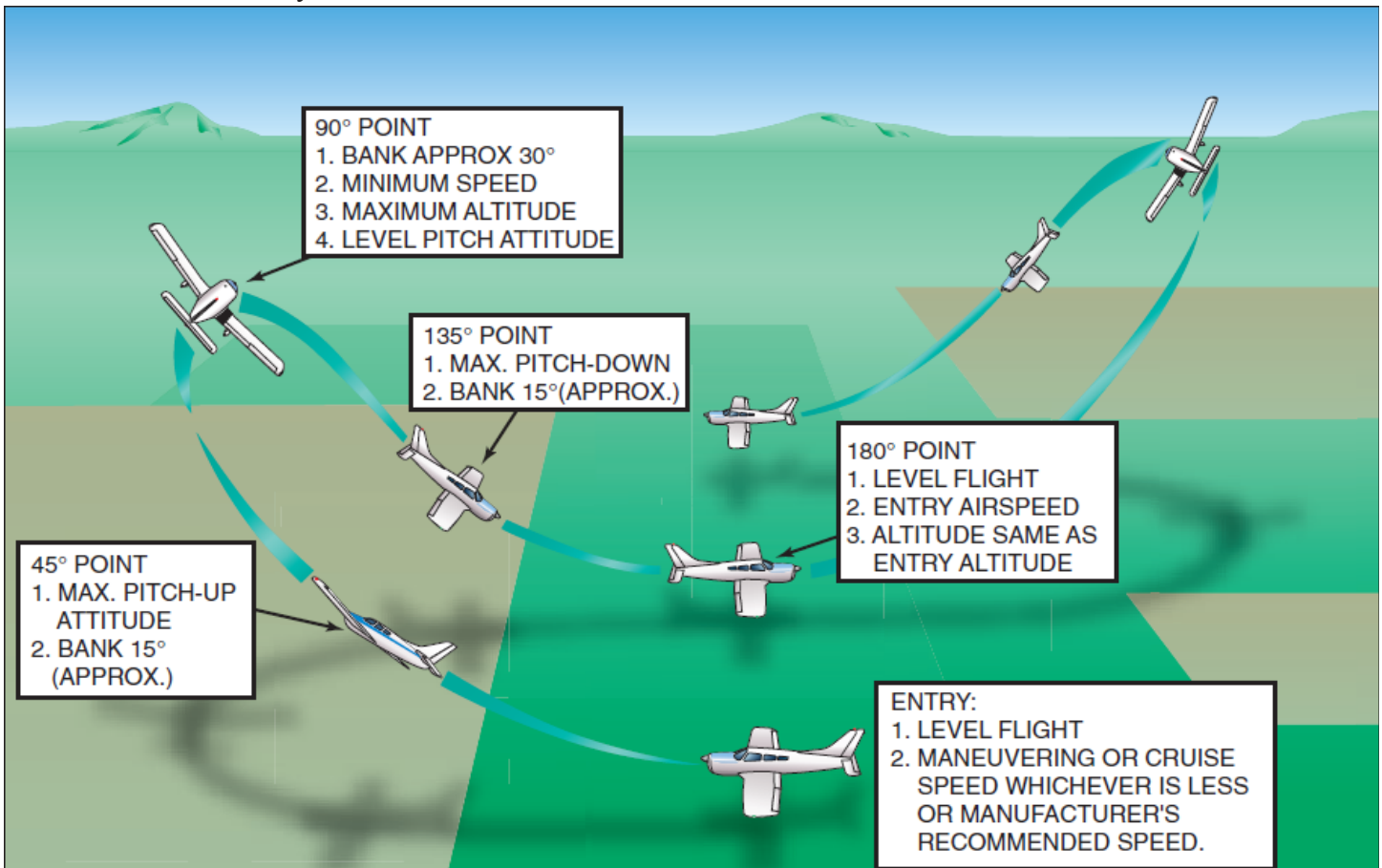

Eights On Pylon

Entry

- Straight-and-level flight at or below V_a (Trottle 22", PROP 2300 RPM).
- Altitude: About pivotal altitude, $=(\text{GS})^2/11.3$
- Tail wind. 45 degree to midpoint of the pylons.

Abeam the pylon

- Bank in order to keep the pylon at the wing tip.
- Adjust pitch to maintain line-of-sight. If the pylon moves forward, descend. If the pylon moves back, climb.

45 degrees before direct downwind

- Roll-out, straight-and-level flight.

Abeam second pylon

- Bank in order to keep the pylon at the wing tip.
- Adjust pitch to maintain line-of-sight. If the pylon moves forward, descend. If the pylon moves back, climb.

45 degrees before direct downwind

- Roll-out, straight-and-level flight.

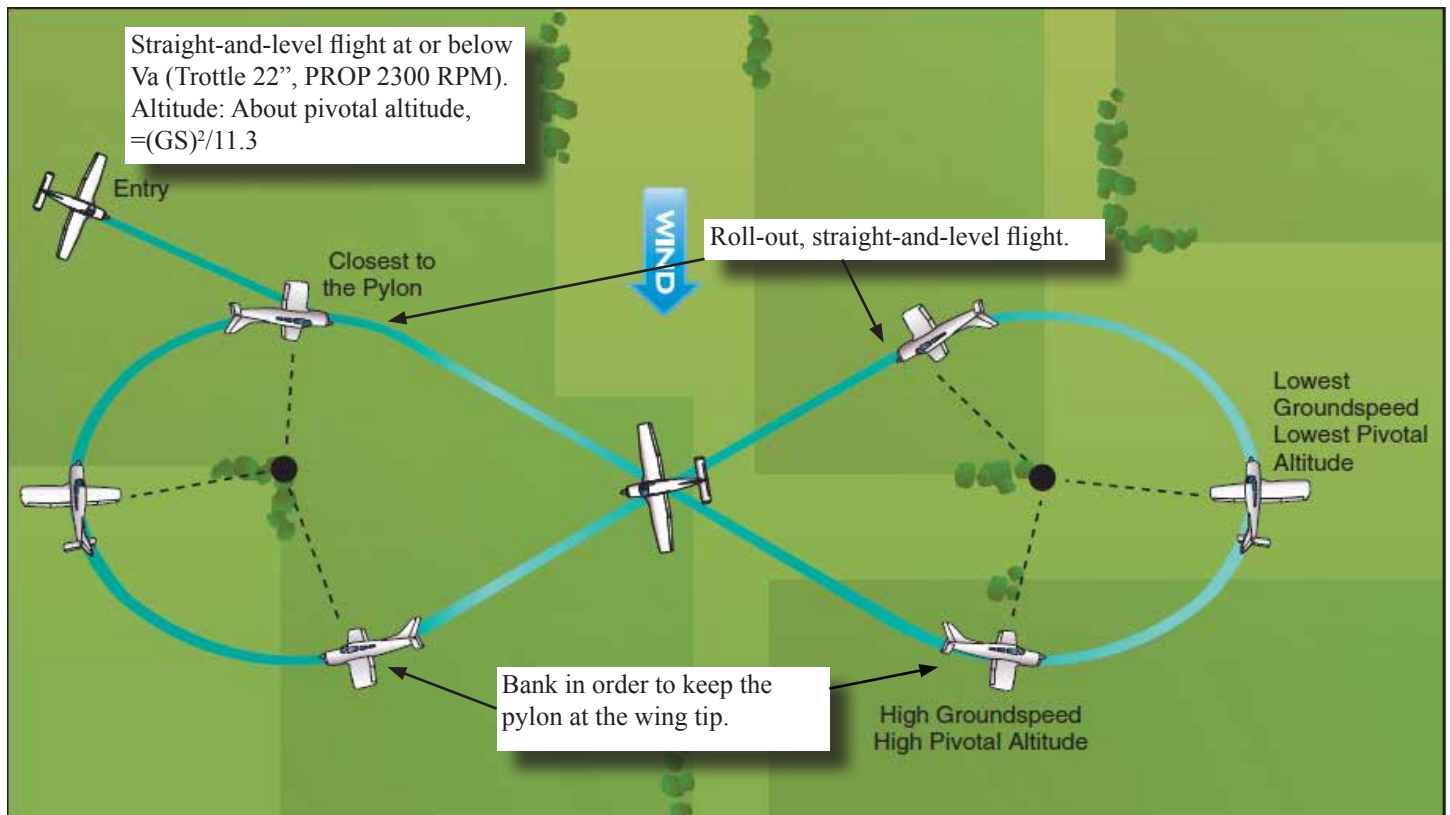

Normal Takeoff

1. Select proper lift off speed for your weight from the performance chart.
2. Taxi into the runway and stop.
3. Set brake. Power 2000 RPM. Check engine gauges.

Pump brake a couple of time before apply full power to prevent the airplane from moving.

4. Release brake. Apply full power.
5. Slightly before lift off speed, rotate. Set pitch up for V_y .

Try not to chase the airspeed indicator needle. Remember, airspeed indicator has lag. If you chase, airspeed may be too slow or too fast.

6. When there is no runway available for landing -Landing gear-Up,
Check “positive rate of climb” before retract the landing gear.
7. Climb at 90kt(V_y).

Traffic Pattern Operation

1. Climb at 90kt(Vy)
2. 500ft AGL,
 - Throttle 25",
 - Prop 2500RPM
3. Turn to crosswind
4. Level of at TPA, Throttle 16~18", maintain 90 Kt
5. Turn to downwind, maintain 90Kt, before landing check
6. At the point where you intercept glideslope,
 - Throttle 15",
 - Gear down,
 - Prop high RPM,
 - Flap 10,
 - Start descend at 90Kt.
7. Turn base
 - Flap 25 degrees
 - 80Kt
 - GUMPS check
8. Turn final, Flap full, adjust airspeed 75Kt
9. Reduce power slowly, Flare and touch down.
10. Brake
11. Taxi out
12. After landing check

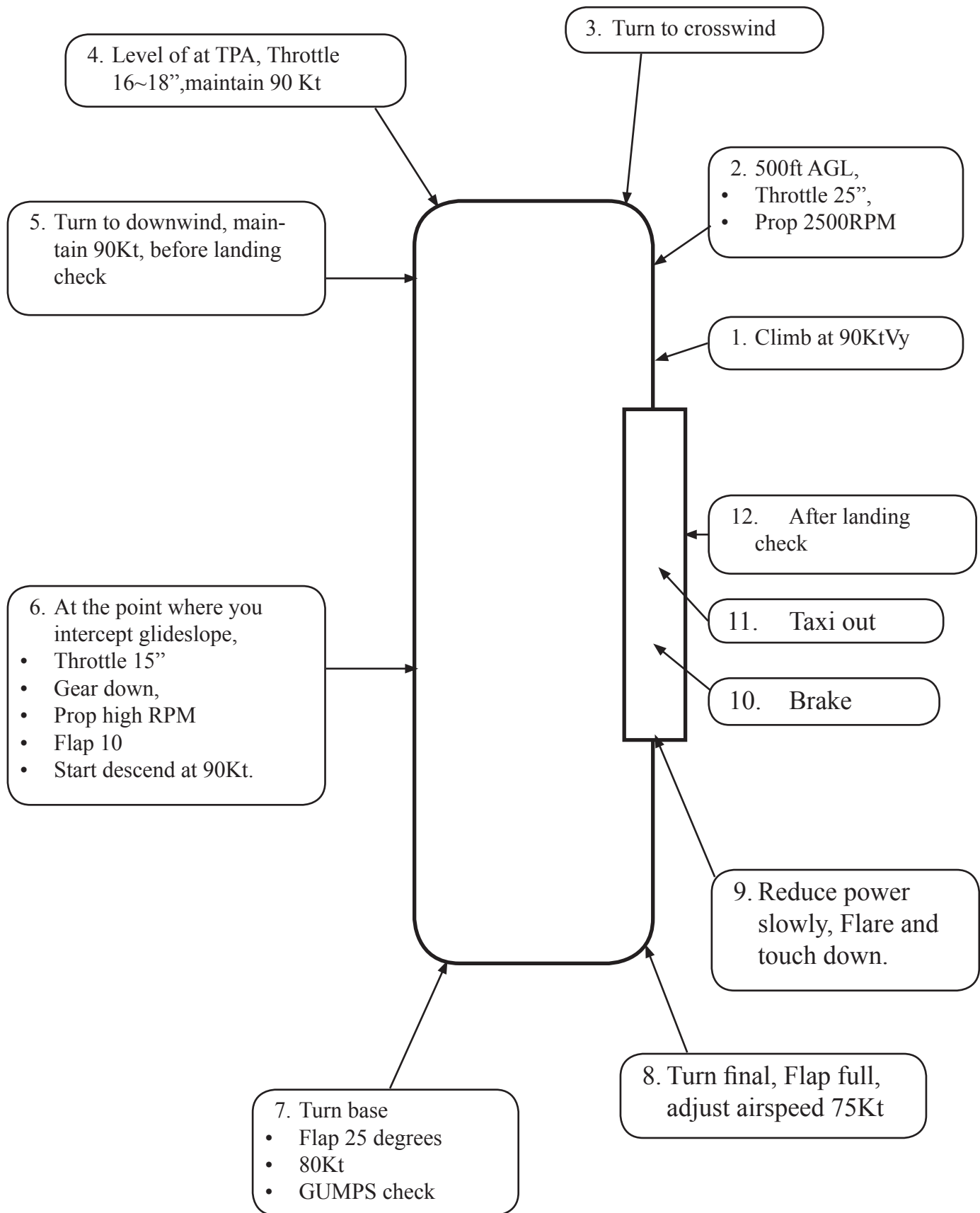

Short Field Takeoff

1. Select proper lift off speed and target speed at 50 ft AGL for your weight from the performance chart.
2. Set 25 degrees flap.
3. Taxi to the very beginning of the runway.
Depend on the traffic situation, you don't need to taxi all the way to the beginning of the runway. You can taxi into position as normal takeoff.
4. Set brake. Full power. Check engine gauges.
Pump brake a couple of time before apply full power to prevent the airplane from moving.
5. Release brake.
6. Slightly before lift off speed, rotate. Set pitch up for the target speed at 50 ft AGL.
Try not to chase the airspeed indicator needle. Remember, airspeed indicator has lag. If you chase, airspeed may be too slow or too fast.
7. At 50ft AGL, lower the nose slightly.
Again, don't chase the needle of airspeed indicator. Look at the pitch attitude. Make small change in the pitch. You still want to climb. Don't descend.
8. Landing gear-Up, Flap-10 degrees.
Check "positive rate of climb" before retract. Once you retract the flap, pitch will change. Be prepare for that.
9. Climb at 90kt(Vy), Flap-Up, Resume normal climb.

Short Field Landing

1. Select proper approach speed for your weight with the performance chart.
2. Approach as normal. Full flap on final.
3. Select the top of the first centerline as the touch down point.

You need to touch down +200/-0ft from that point(private), +100/-0ft (commercial). In this way, you can keep the runway number as the aiming point same as for normal landing.
4. Maintain proper approach speed kt at least last 1/4 mile on final.

You don't need to make steep or shallow approach. Just maintain normal approach path all the way to the runway number.
5. Clear the brake

Make sure that your toes don't touch the brake. Your toe must be on the lower part of the pedal to avoid locking the tire.
6. Reduce power, flare touchdown.

Do as you do for normal landing. If your approach was correct, it will touch down the point. If your approach was wrong, there is no way to correct at this point. Do no try to touch down on the point by lowering the nose or by releasing back pressure. You will land flat and damage the airplane. If you think you will over shoot, commence go around and make the better approach next time.
7. After touch down, as you maintain directional control, use NORMAL BRAKE.

In real short field situation, you may need to retract the flap and use full brake. However, during training, we want to avoid gear up on the runway and locking the brake, making flat spot on the tires caused by improper use of "full brake". You call out "Flap up, full brake" and use normal brake instead of full. Leave the flap down.

Soft Field Takeoff

1. Set 25 degrees flap.
2. Apply full back pressure on the elevator.
3. Taxi into the runway with minimum brake.
4. Join the center line.
5. Apply full power
6. When nose is going up, release back pressure to keep the nose slightly off the ground.

Nose should not be too high. The purpose is to reduce the load on the nose gear. Avoid tail from hitting the ground.

7. Lift off-Level off. Accelerate in the ground effect.
8. 72kt, climb attitude.
9. Positive climb, Gear-up, Flap-10.
10. 78kt, Flap-Up. Resume normal climb.

Soft Field Landing

1. Approach as normal. Full flap on final.
2. Select the top of the first centerline as the touch down point.

You need to touch down +200/-0ft from that point(private), +100/-0ft (commercial). In this way, you can keep the runway number as the aiming point same as for normal landing.
3. Maintain proper approach speed kt at least last 1/4 mile on final.

You don't need to make steep or shallow approach. Just maintain normal approach path all the way to the runway number.
4. Clear the brake

Make sure that your toes don't touch the brake. Your toe must be on the lower part of the pedal to avoid locking the tire.
5. Reduce power, flare.
6. When nose is above horizon-Add power slightly
7. After touch down, power idle. Maintain directional control, lower the nose. Let the airplane slow down without the brake on the real soft field.
8. Taxi out. After landing check list.

Instrument Approach Procedure

1. ATIS (When you are close to destination)
2. Descend check list
 - Heading indicator-set
 - Altimeter-set
 - Fuel selector valve-Fullest tank
3. Complete approach briefing
4. Set approach configuration (on initial approach segment or vectored for downwind)
 - Throttle-15"
 - Prop-2500 RPM.
 - AS<103, Flap-10
 - Throttle-16" to 17" enough to maintain 90Kt.
5. Before landing check (except gear and prop)
6. Step down
 - Throttle-12"
 - Nose-lower for descend
7. Level off
 - Nose-level
 - Throttle-16" to 17" enough to maintain 90Kt.
8. FAF(intercepting GS for ILS)
 - Gear-down
 - Prop-high RPM
 - Flap-25
 - Start descend (500FPM for ILS)
 - 5 Ts (turn, time, twist, throttle, talk)
9. GUMPS check
10. At MDA-level off, Throttle-20" to 22".
 - When you see the runway-full flap, slow down to 75Kt, flare and touchdown.
 - If you reach missed approach point with no visual clue, commence missed approach.
11. Missed approach
 - Throttle-full
 - Positive climb-gear up, flap up
 - Climb at 90(Vy)
 - Comply missed approach instruction or as published
 - Complete after takeoff check list

Engine Failure

1. Best Glide speed 79kt, trim it.
 - Establish pitch attitude which gives you 79kt.
2. Look for landing spot, turn toward it.
3. Trouble shoot-Use check list, Or Flow check
 - Seat belt-lock
 - Mixture-rich
 - Master switch-on
 - Fuel pump-on
 - Alternate Air-open
 - Ignition switch-both
 - Fuel valve-switch
4. Declare emergency
 - Transponder-7700
 - Radio-121.5 or current ATC
 - “Mayday Mayday Mayday, Arrow 36574, ENGINE FAILURE, (position), Making forced landing into (landing spot), 2 persons on board.”
5. Secure Engine
 - Prop-full back to reduce drag
 - Mixture-Idle cut-off
 - Fuel valve-off
 - Ignition switch-off
 - After extend the gear, master switch-off
6. Door-open
7. Touch down
8. Stop the airplane
 - Inspect your body condition
 - Get out of airplane
 - Make sure no fire
 - Call Nice Air, (408)729-3383, police, 911